

Product Description

Line: Bathroom Set
Type: Dispenser wall Mounted
Code: 91356
Metal: Brass

Product Photo



Mounting Instructions

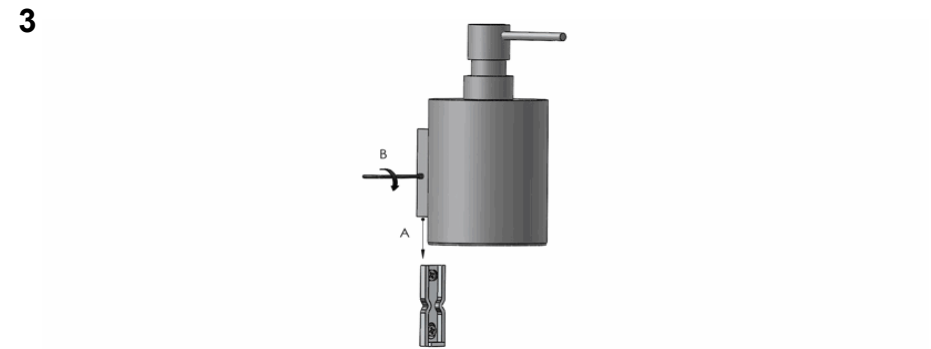
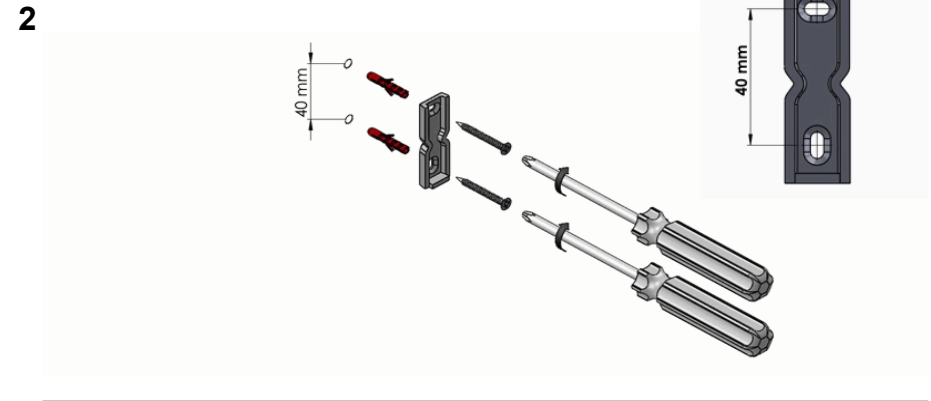
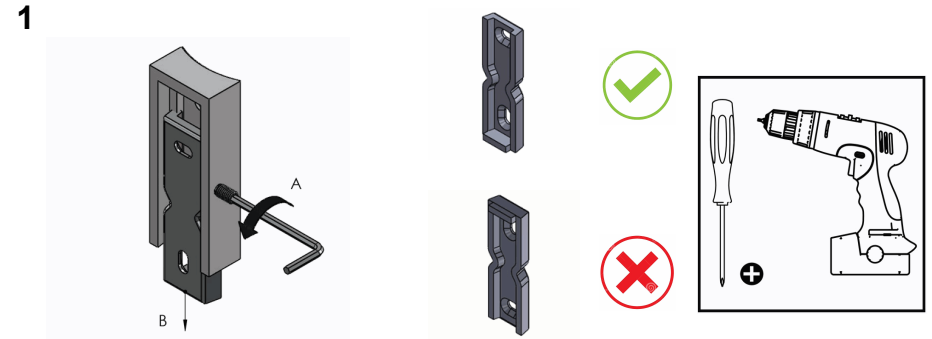

Technical Sheet

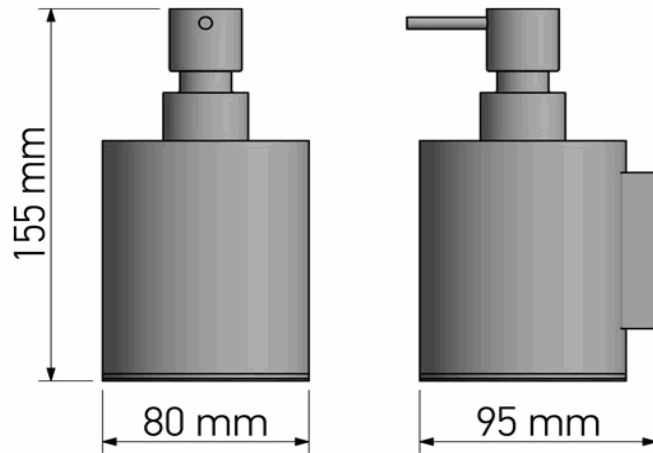

KATSIERIS BROS S.A.

Industry Bathroom accessories, Design & Manufacturing, Koropi Industrial Region, Loc: Poka 194 00, Koropi P.O. 27. Athens-Greece T:+30 210 6627 500 info@sanco.gr, www.sanco.gr



Quality Management System
EAOT EN ISO 9001:2008
 Cert. No 1008/A/2010



Environmental Management System
EAOT EN ISO 14001:2004
 Cert. No 144/1/2010

