

## Product Description

Line : Bathroom Set  
 Type : Portable Dispenser  
 Code : 90352



## Technical Sheet

Finishing : Chrome  
 Metal : Brass

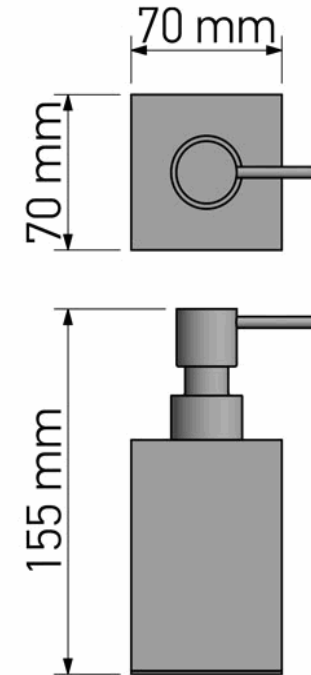

### KATSIERIS BROS S.A.

Industry Bathroom accessories, Design & Manufacturing, Koropi Industrial Region, Loc: Poka 194 00, Koropi P.O. 27. Athens-Greece T:+30 210 6627 500, F:+30 210 6626 830  
 info@sanco.gr, www.sanco.gr



Quality Management System  
**EAOT EN ISO 9001:2008**  
 Cert. No 1008/Δ/2010



Environmental Management System  
**EAOT EN ISO 14001:2004**  
 Cert. No 144/Γ/2010

