

Product Description

Line Ergon
 Type Sponge Dish
 Code 25943-A03

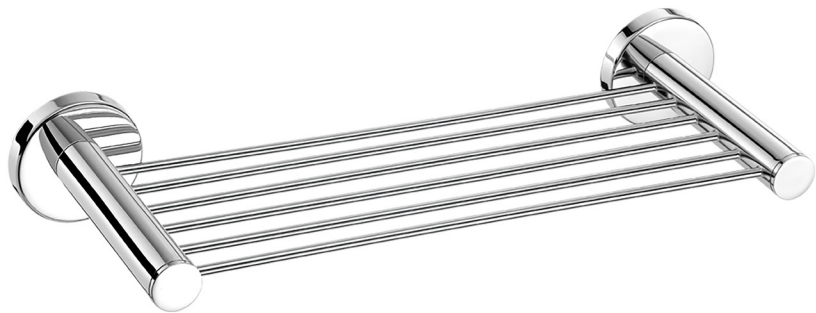

Technical Sheet

Finishing Chrome
 Metal Brass

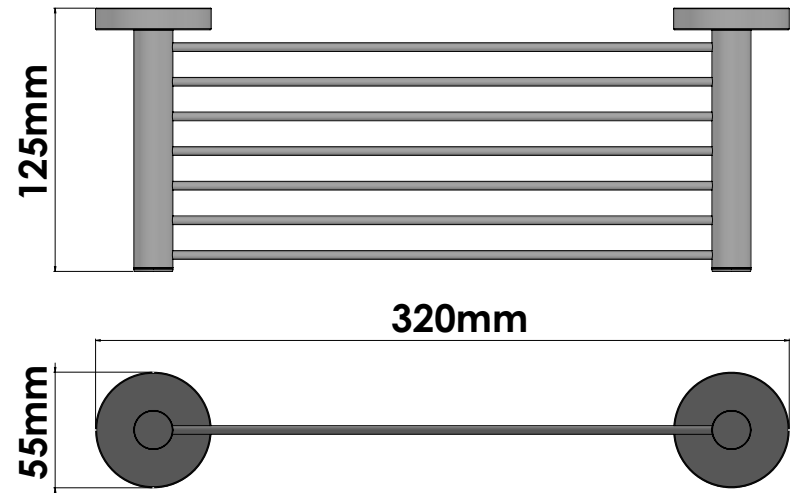

KATSIERIS BROS S.A.

Industry Bathroom accessories, Design & Manufacturing, Koropi Industrial Region, Loc: Poka 194 00, Koropi P.O. 27. Athens-Greece T:+30 210 6627 500, info@sanco.gr, www.sanco.gr

