

Product Description

Line: Ergon Project

Type: Sponge Dish

Code: 25943

Metal: Brass

Product Photo



Mounting Instructions

1

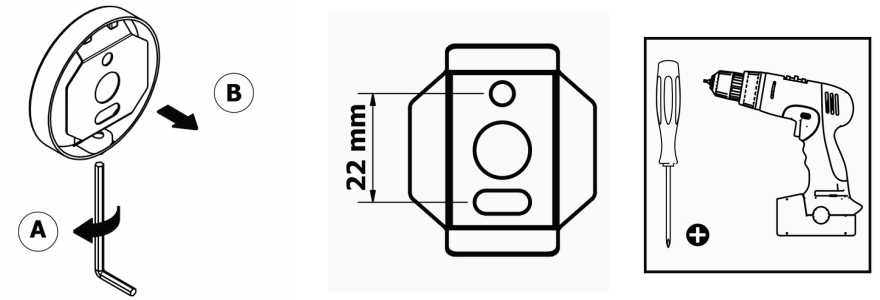

2

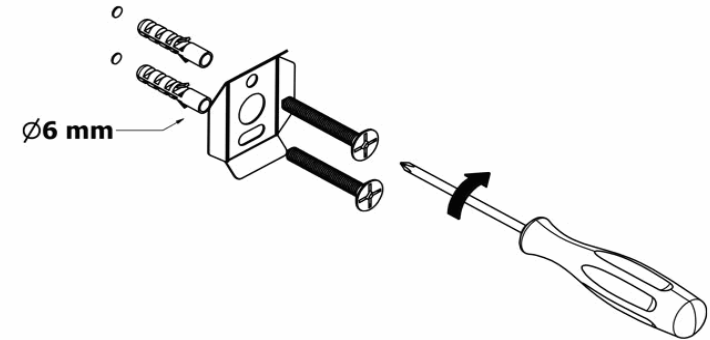

3

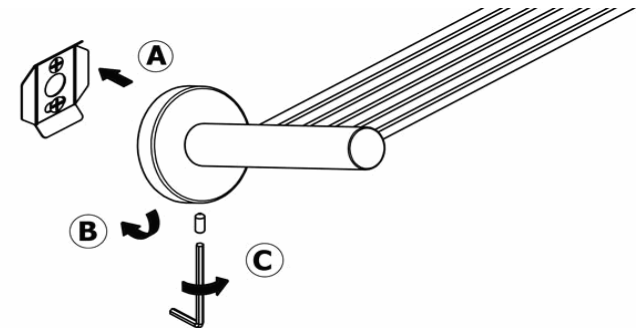

Technical Sheet

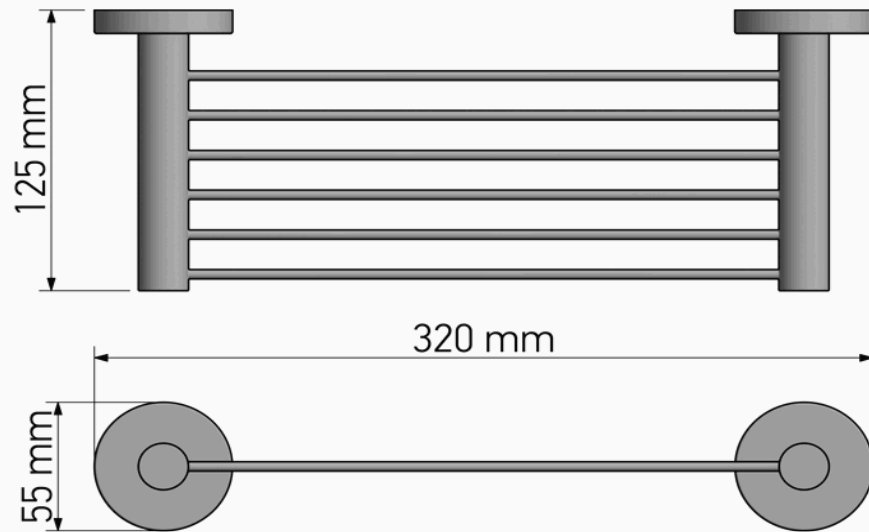

KATSIERIS BROS S.A.

Industry Bathroom accessories, Design & Manufacturing, Koropi Industrial Region, Loc: Poka 194 00, Koropi P.O. 27. Athens-Greece T:+30 210 6627 500, F:+30 210 6626 830
info@sanco.gr, www.sanco.gr



Quality Management System
EAOT EN ISO 9001:2008
Cert. No 1008/A/2010



Environmental Management System
EAOT EN ISO 14001:2004
Cert. No 144/T/2010

