

## Product Description

Line Lithos  
 Type Dispenser wall mounted  
 Code 190356-A03



## Technical Sheet

Finishing Chrome  
 Metal Brass

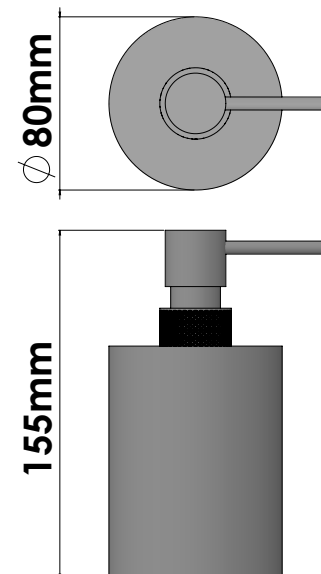

**KATSIERIS BROS S.A.**

Industry Bathroom accessories, Design & Manufacturing, Koropi Industrial Region, Loc: Poka 194 00, Koropi P.O. 27. Athens-Greece T:+30 210 6627 500, info@sanco.gr, www.sanco.gr

