

## Product Description

Line : Tempo  
Type : Sponge Dish  
Code : 14043

## Technical Sheet

Finishing : Chrome  
Metal : Brass

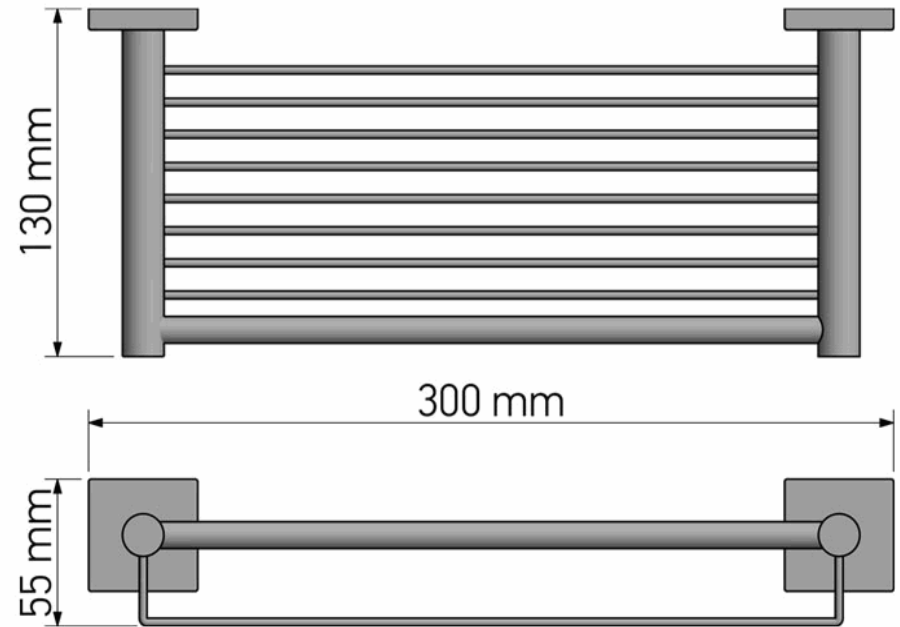
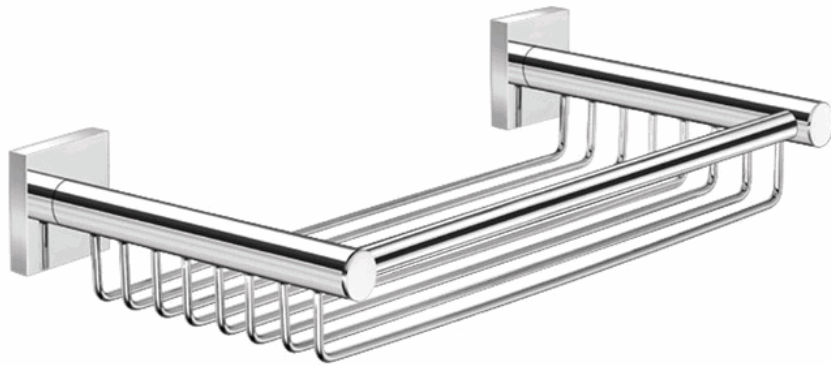

### KATSIERIS BROS S.A.

Industry Bathroom accessories, Design & Manufacturing, Koropi Industrial Region, Loc: Poka 194 00, Koropi P.O. 27. Athens-Greece T:+30 210 6627 500, F:+30 210 6626 830  
info@sanco.gr, www.sanco.gr



Quality Management System  
EAOT EN ISO 9001:2008  
Cert. No 1008/A/2010



Environmental Management System  
EAOT EN ISO 14001:2004  
Cert. No 144/I/2010

