

Product Description

Line Extra
Type Amenities Tray (AISI 304)
Code 0122-A90



Technical Sheet

Finishing Inox
Metal INOX AISI 304

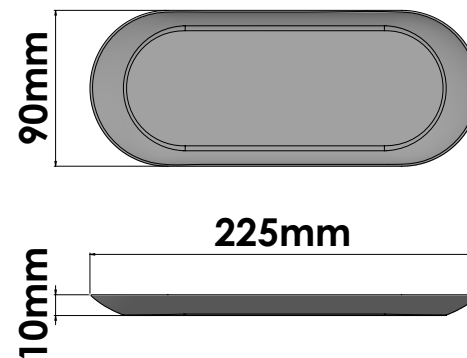

KATSIERIS BROS S.A.

Industry Bathroom accessories, Design & Manufacturing, Koropi Industrial Region, Loc: Poka 194 00, Koropi P.O. 27. Athens-Greece T:+30 210 6627 500, info@sanco.gr, www.sanco.gr

