

Product Description

Line : Shower Shelves
 Type : Shower shelf (AISI 304)
 Code : 00344

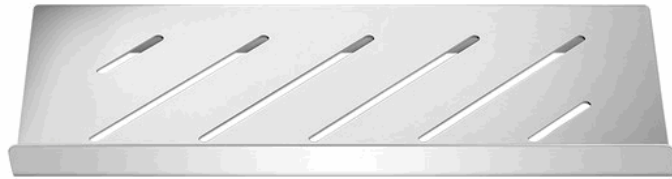

Technical Sheet

Finishing : Inox
 Metal : INOX AISHI 304

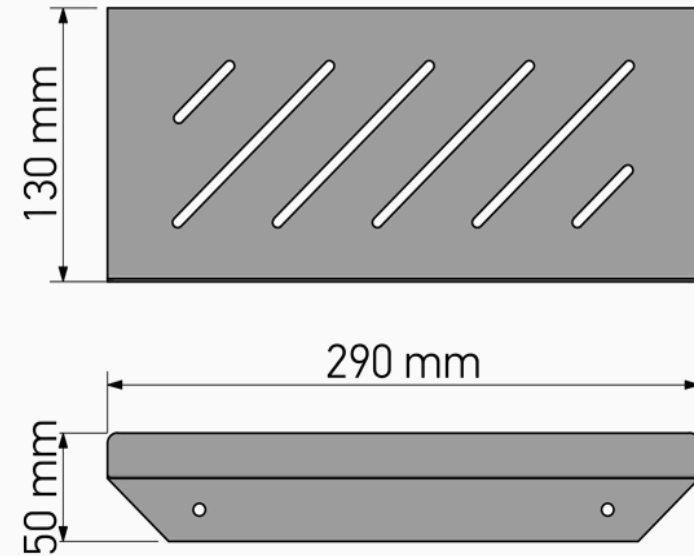

KATSIERIS BROS S.A.

Industry Bathroom accessories, Design & Manufacturing, Koropi Industrial Region, Loc: Poka 194 00, Koropi P.O. 27. Athens-Greece T:+30 210 6627 500, F:+30 210 6626 830
 info@sanco.gr, www.sanco.gr



Quality Management System
EAOT EN ISO 9001:2008
 Cert. No 1008/Δ/2010



Environmental Management System
EAOT EN ISO 14001:2004
 Cert. No 144/Γ/2010

